

This drawing includes confidential information which is the property of ASHCROFT INC. This copy is loaned for a specific purpose, with the understanding that it will not be reproduced or used for any other purpose or disclosed to others, and it will be returned on demand.

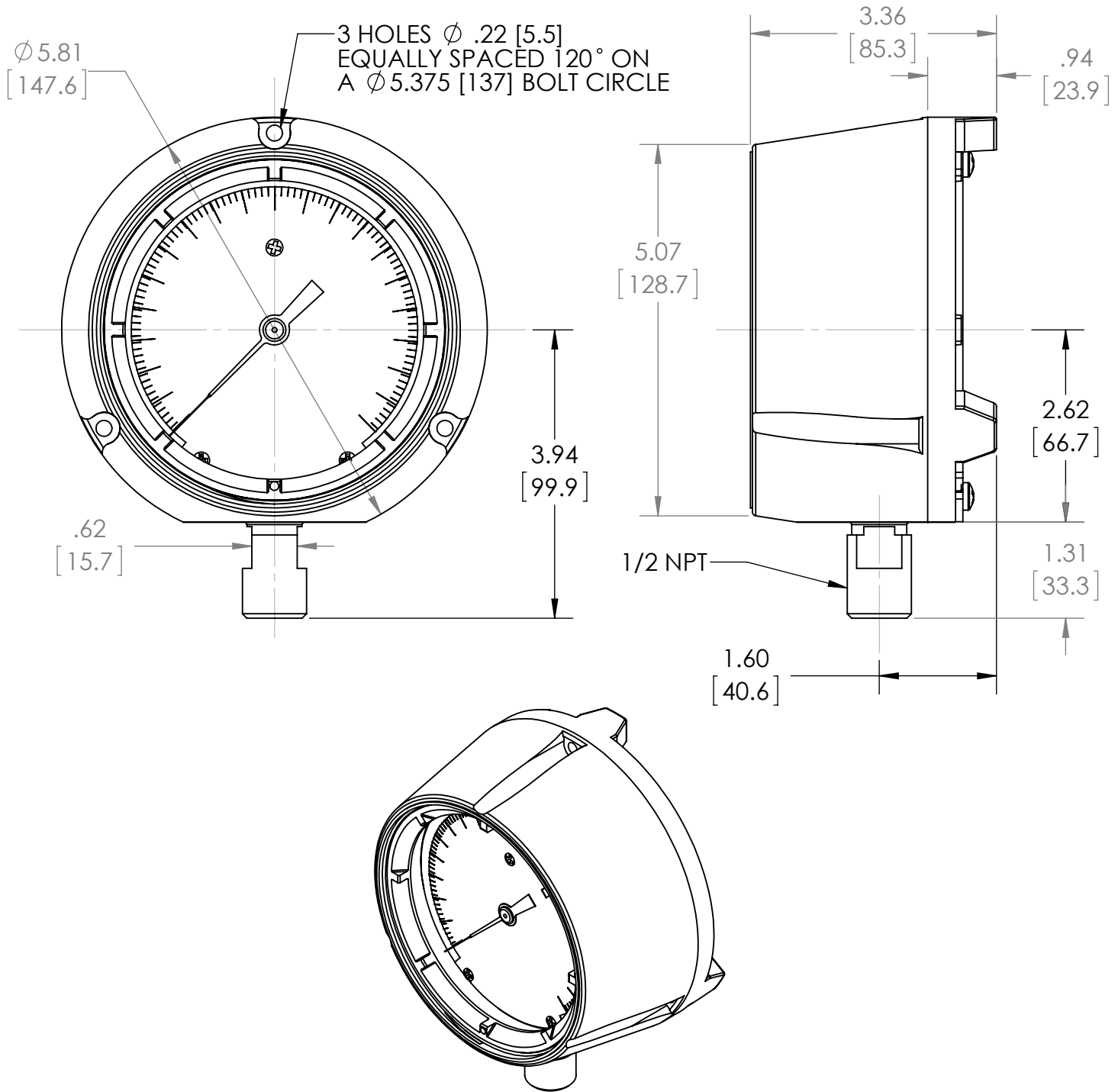

REV	ECO	DESCRIPTION	BY	DATE
A	6335	INITIAL RELEASE	JDB	3/25/2013

This print certified correct for		GENERAL DIMENSIONS			
Customer's Name		45 1082 04L XTY SERIES			
		TURRET CASE TEST GAUGE			
Customer's Order No.	Drawn JDB	Date 3/25/2013	Date of Issue		
Ashcroft Order No.	Checked	Date	SHEET-1		Rev.
Certified by	Date	Approved	Date	70A3973	A