

This drawing includes confidential information which is the property of ASHCROFT INC. This copy is loaned for a specific purpose, with the understanding that it will not be reproduced or used for any other purpose or disclosed to others, and it will be returned on demand.

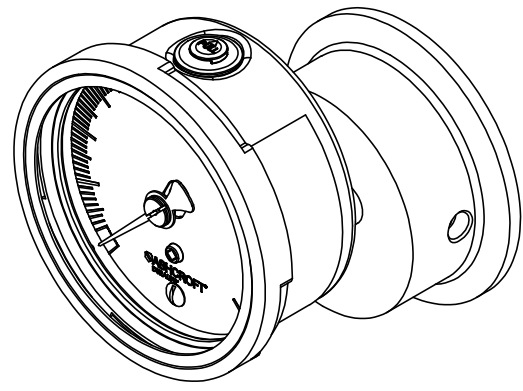
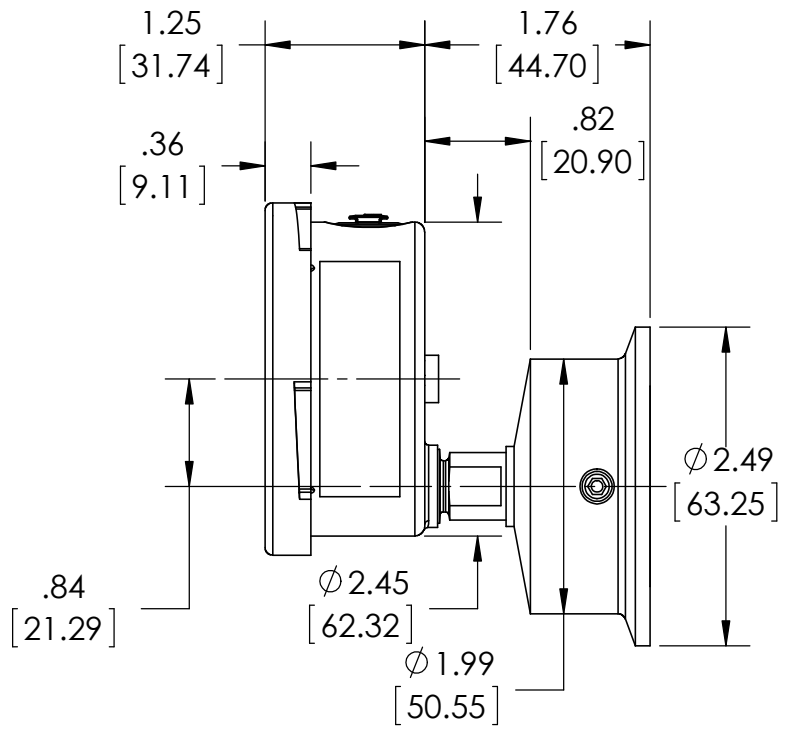
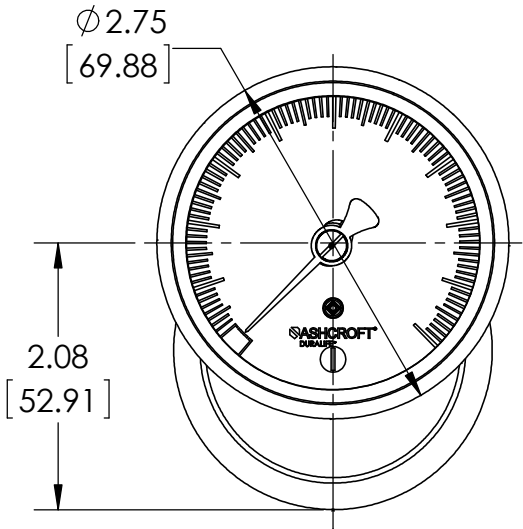

DIMENSIONS IN [] ARE MILLIMETERS

REV.	ECO	DESCRIPTION	BY	DATE
A	0004508	RELEASED GENERAL DIMS.	MJS	6/13/2011

This print certified correct for		General Dimensions		
Customer's Name		ASHCROFT 25 1032 20B SERIES		
		SANITARY GAUGE		
Customer's Order No.	Drawn MJS	Date 6/13/11	Date of Issue	
Ashcroft Order No.	Checked	Date	SHEET-1	Rev.
Certified by	Date	Approved	Date	70A3489
				A