

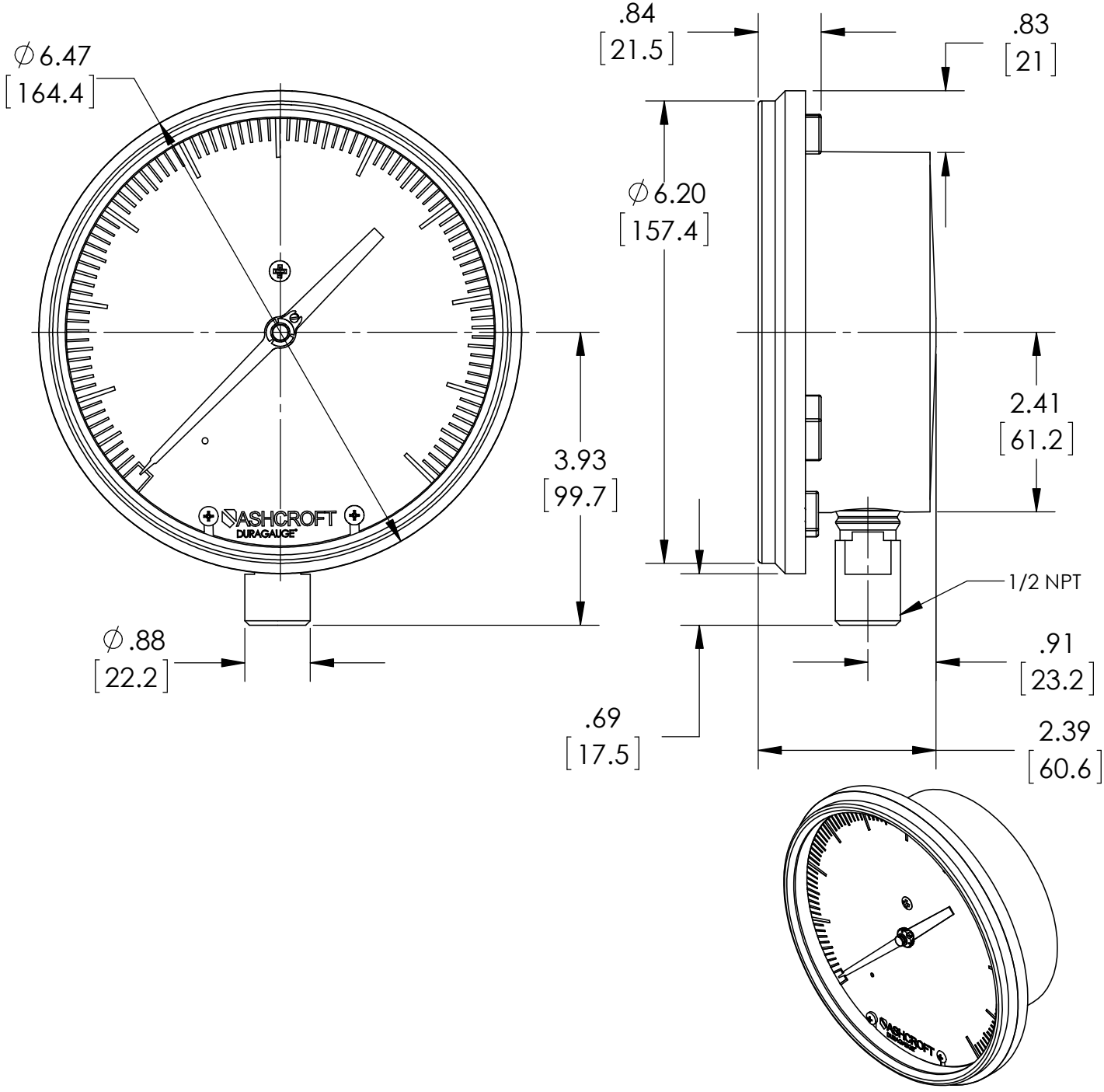

This drawing includes confidential information which is the property of ASHCROFT INC. This copy is loaned for a specific purpose, with the understanding that it will not be reproduced or used for any other purpose or disclosed to others, and it will be returned on demand.

ASHCROFT INC.

250 EAST MAIN STREET
STRATFORD, CT 06614



DIMENSIONS IN [] ARE MILLIMETERS

REV.	ECO	DESCRIPTION	BY	DATE
B	0007035	REDEFINED AS 60 2462 04L	ALH	2/27/2014

This print certified correct for		General Dimensions			
Customer's Name		60 2462 04L SERIES			
		POLYPROPYLENE CASE DURAGAUGE			
Customer's Order No.	Drawn MJS	Date 6/1/10	Date of Issue		
Ashcroft Order No.	Checked	Date	SHEET-1		Rev.
Certified by	Date	Approved	Date	70A3043	B