

This drawing includes confidential information which is the property of ASHCROFT INC. This copy is loaned for a specific purpose, with the understanding that it will not be reproduced or used for any other purpose or disclosed to others, and it will be returned on demand.

ASHCROFT INC.

250 EAST MAIN STREET
STRATFORD, CT 06614

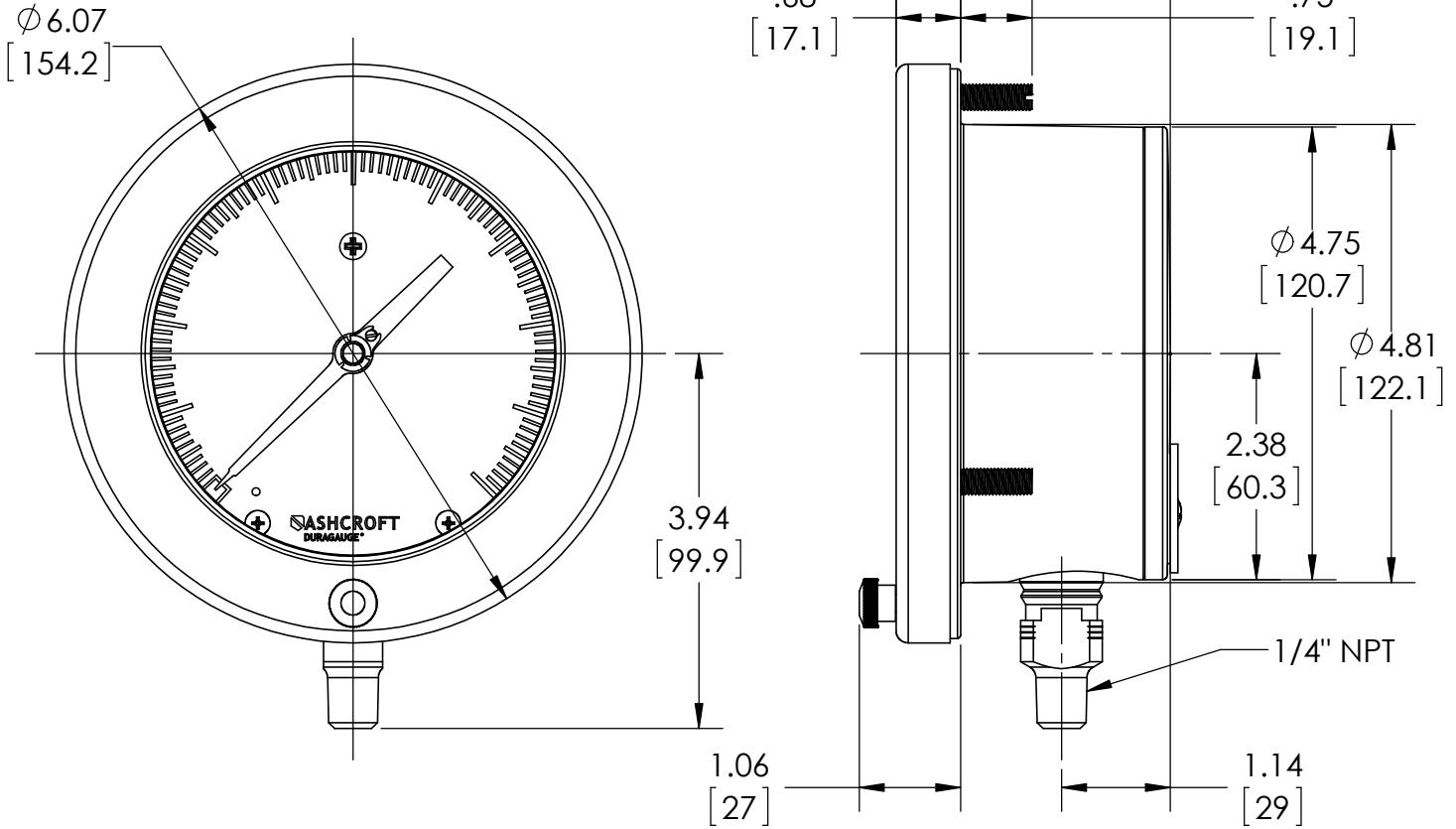

Note: 3 Mounting studs threaded equally spaced on a 5.375" [137] Bolt Circle.

DIMENSIONS IN [] ARE MILLIMETERS

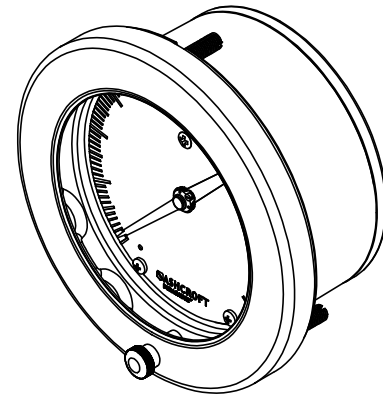

REV.	ECO	DESCRIPTION	BY	DATE
A	Un-Rel	RELEASED GENERAL DIMS. FOR 45 1377 02L	MJS	5/26/2010
B	Un-Rel	Validation of Dimensions for 1377 Draw ings	MJS	2/10/2012
C	0005650	Revised Dimensions for 45-1377 Draw ings	MJS	5/11/2012

This print certified correct for		General Dimensions			
Customer's Name		45 1377 02L SERIES			
		HINGED RING DURAGAUGE			
Customer's Order No.	Drawn MJS	Date 5/26/10	Date of Issue		
Ashcroft Order No.	Checked	Date	SHEET-1		Rev.
Certified by	Date	Approved	Date	70A3015	C